

**TYP/TYPE 802D**

**VRTÁKY S VYMĚNITELNÝMI BŘITOVÝMI DESTIČKAMI INDEXABLE INSERT DRILLS**

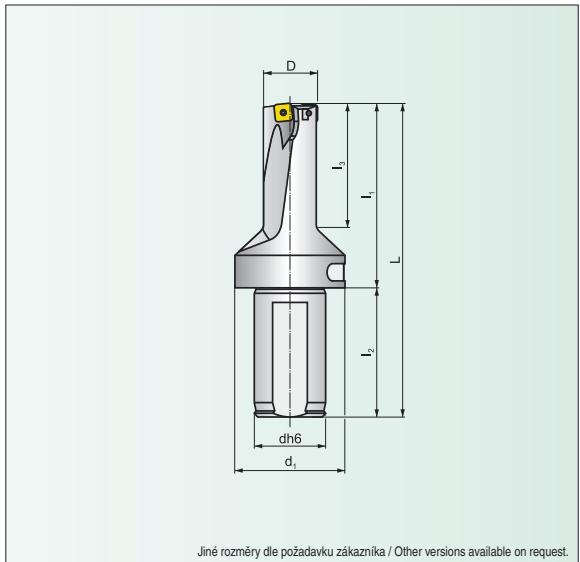

Jiné rozměry dle požadavku zákazníka / Other versions available on request.

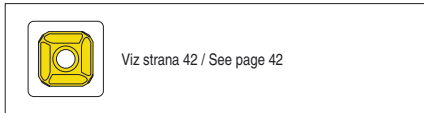
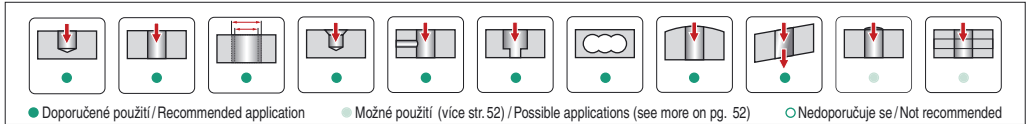

D	h	Označení vrtáku Marking of drill	Sortiment/Assortment	Rozměry / Dimensions						Sřídová destička Centre insert	Obvodová destička Peripheral insert	Radiální nastavení Radial adjustment	
				L	L <sub>1</sub>	L <sub>2</sub>	L <sub>3</sub>	dh6	d <sub>1</sub>			-	+
15	30	802D-15	●	121,0	65,0	56	34,5	25	45	0502AP	0502..	0,30	0,30
16	32	802D-16	●	123,0	67,0	56	37,0	25	45	0502AP	0502..	0,15	0,40
17	34	802D-17	●	125,0	69,0	56	39,5	25	45	0502AP	0502..	0,15	0,50
18	36	802D-18	●	127,0	71,0	56	42,0	25	45	0602AP	0502..	0,35	0,20
19	38	802D-19	●	129,0	73,0	56	44,5	25	45	0602AP	0602..	0,30	0,35
20	40	802D-20	●	131,0	75,0	56	47,0	25	45	0602AP	0602..	0,20	0,50
21	42	802D-21	●	133,0	77,0	56	49,5	25	45	0602AP	0602..	0,10	0,50
22	44	802D-22	●	135,0	79,0	56	52,0	25	45	0703AP	0602..	0,50	0,40
23	46	802D-23	●	137,0	81,0	56	54,5	25	45	0703AP	0703..	0,50	0,50
24	48	802D-24	●	139,0	83,0	56	57,0	25	45	0703AP	0703..	0,50	0,50
25	50	802D-25	●	145,0	85,0	60	57,0	32	50	0703AP	0703..	0,30	0,50
26	52	802D-26	●	147,0	87,0	60	59,5	32	50	0703AP	0703..	0,10	0,50
27	54	802D-27	●	149,0	89,0	60	62,0	32	50	0903AP	0703..	0,50	0,20
28	56	802D-28	●	151,0	91,0	60	64,5	32	50	0903AP	09T3..	0,50	0,35
29	58	802D-29	●	153,0	93,0	60	67,0	32	50	0903AP	09T3..	0,50	0,50
30	60	802D-30	●	155,0	95,0	60	69,5	32	50	0903AP	09T3..	0,35	0,50
32	64	802D-32	●	167,0	99,0	68	70,0	40	59	0903AP	09T3..	0,15	0,50
32	64	802D-32-S32	●	159,0	99,0	60	70,0	32	59	0903AP	09T3..	0,15	0,50
34	68	802D-34	●	171,0	103,0	68	75,0	40	59	11T3AP	09T3..	0,50	0,50
34	68	802D-34-S32	●	163,0	103,0	60	75,0	32	59	11T3AP	09T3..	0,50	0,50
36	72	802D-36	●	173,0	105,0	68	77,5	40	59	11T3AP	1204..	0,10	0,50



● Skladovaný / Stock Assort.    ○ Neskladovaný / Non-stock assort.    Všechny rozměry v [mm] / All dimensions [mm]



**TYP/TYPE 802D**
**VRTÁKY S VYMĚNITELNÝMI BŘITOVÝMI DESTIČKAMI  
INDEXABLE INSERT DRILLS**

D		Označení vrtáku Marking of drill	Sortiment / Assortment	Rozměry / Dimensions						Středová destička Centre insert XPET	Obvodová destička Peripheral insert SCET	Radiální nastavení Radial adjustment	
				L	l <sub>1</sub>	l <sub>2</sub>	l <sub>3</sub>	dh6	d <sub>1</sub>			-	+
36	72	<b>802D-36-S32</b>	●	167,0	107,0	60	80,0	32	59	<b>11T3AP</b>	<b>1204..</b>	0,10	0,50
38	76	<b>802D-38</b>	●	179,0	111,0	68	85,0	40	59	<b>11T3AP</b>	<b>1204..</b>	0,15	0,50
38	76	<b>802D-38-S32</b>	●	171,0	111,0	60	85,0	32	59	<b>11T3AP</b>	<b>1204..</b>	0,15	0,50
40	80	<b>802D-40</b>	●	183,0	115,0	68	90,0	40	59	<b>12T3AP</b>	<b>1204..</b>	0,35	0,50
40	80	<b>802D-40-S32</b>	●	175,0	115,0	60	90,0	32	59	<b>12T3AP</b>	<b>1204..</b>	0,35	0,50

**NÁHRADNÍ DÍLY / SPARE PARTS**

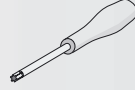
Vrták Drill	Upínací šroub - vnitřní VBD Clamping screw - internal insert	Upínací šroub - vnější VBD Clamping screw - external insert	Šroubovák Screwdriver
Ø15 ÷ Ø17	 US 2245-T07P	 US 2245-T07P	 SDR T07P
Ø17,5 ÷ Ø18,5	US 2205-T07P	US 2245-T07P	SDR T07P
Ø19 ÷ Ø21	US 2205-T07P	US 2205-T07P	SDR T07P
Ø21,5 ÷ Ø22	US 2506-T07P	US 2506-T07P	SDR T07P
Ø22,5 ÷ Ø26	US 2507-T08P	US 3007-T08P	SDR T08P
Ø26,5 ÷ Ø27	US 3007-T09P	US 3007-T09P	SDR T09P
Ø28 ÷ Ø32	US 3007-T09P	US 3009-T09P	SDR T09P
Ø33 ÷ Ø34	US 3508-T15P	US 3508-T15P	SDR T15P
Ø35 ÷ Ø40	US 3508-T15P	US 5012-T15P	SDR T15P

● Skladovaný / Stock Assort.

○ Neskladovaný / Non-stock assort.

Všechny rozměry v [mm] / All dimensions [mm]